

A photograph of industrial machinery, likely a conveyor belt system, with a large, silver-framed multi-touch monitor mounted on the side. The background is a mix of yellow and purple tones.

Kingdy Industrial (Multi) Touch Monitor

A full range of solutions for a wide variety of industrial criteria including extreme temperature resistance or sunlight readable



Kingdy Industrial (Multi) Touch Monitor

Challenges

For PC-based automation system deployers preferring traditional standalone or client-server architecture for technical or economic reasons, an industrial rated touch monitor is an essential device to link up operators with the system. Radically different from commercial or residential applications, industrial environments are usually harsh, with hazards that can range from extreme temperatures, ambient light disturbance, water & dust intrusion, corrosion and oily & greasy contamination. The resistance to one or some of the above-mentioned factors should not be ignored when assessing whether a monitor can well work with the system.

Solutions

In response to different environmental conditions, Kingdy develops a full range of solutions featuring one or some of the following characteristics and allowing entrepreneurs to easily select and deploy an appropriate monitor to address the challenge(s) they are facing.

- Wide operating temperature range
- Sunlight readability
- Full IP65 water-/dust-proofing
- 19" rack mountability

Collections

Category	Series	Touch		Condition				Panel Size									
		Single	Multi	Std.	Sunlight Readable	Wide Temp.	Wide Temp. Sunlight Readable	4:3						16:9			
								8.4"	10.4"	12.1"	15"	17"	19"	15.6"	17.3"	21.5"	
Aluminum Bezel	SM	☉		★				V	V	V	V	V	V	V	V	V	V
	HM	☉			★				V	V	V	V	V				V
	DM	☉				★			V	V	V	V	V				
	LM	☉					★		V	V	V	V					
	TM		☉	★					V	V	V	V	V				V
	UM		☉		★				V	V	V	V	V				V
	EM		☉			★			V	V	V	V	V				
	VM		☉				★		V	V	V	V					
19" Rack mount Aluminum Bezel	RM	☉		★				V	V	V	V	V					
	GM	☉			★			V	V	V	V	V					
	FM	☉				★		V	V	V	V	V					
	BM	☉					★	V	V	V	V						
	AM		☉	★				V	V	V	V	V					
	CM		☉		★			V	V	V	V	V					
	KM		☉			★		V	V	V	V	V					
	QM		☉				★	V	V	V	V						
Full IP65 Stainless Steel Chassis	SA	☉		★							V	V	V				V
	HA	☉			★						V	V	V				V
	DA	☉				★					V	V	V				
	LA	☉					★				V	V					
	TA		☉	★							V	V	V				V
	UA		☉		★						V	V	V				V
	EA		☉			★					V	V	V				
	VA		☉				★				V	V					

SM Series Standard Monitor



Touch Function



Waterproof Design



Housing Design



OSD Controller



IP65 front bezel,
Waterproof gasket (optional)

Aluminum front bezel + metal chassis

Rear side

Power Supply	DC in 12V external power adapter (DC in 19V ~ 36V optional for 17", 19" & 21.5")
I/O Ports (Default)	1 x VGA, 1 x DVI, 1 x USB or RS232 for resistive touch screen, 1 x Power terminal block (15" & 21.5")
I/O Ports (Optional)	1 x HDMI (15" ~ 21.5")
Operation Temperature	0°C ~ 45°C
Storage Temperature	-10°C ~ 70°C
Relative Humidity	0% ~ 95% non-condensing
OS Support	Win 7 Pro, Embedded 7, Win XP Pro, Embedded XP
Installation	Clip mount, Panel mount & VESA mount 75 x 75 mm (8.4" ~ 12.1") / 100 x 100 mm (15" ~ 21.5")
Optional Items	Waterproof gasket, None touch screen, Open frame, Stainless front bezel, Mounting clips

Model Name	12V	SM-ZJR08RF	SM-ZJR10RF	SM-ZJS10RF	SM-ZJR12RF	SM-ZJS12RF	SM-ZJL15RF
	19~36V	-	-	-	-	-	-
Display	Size / Aspect Ratio	8.4" TFT (4:3)	10.4" TFT (4:3)	10.4" TFT (4:3)	12.1" TFT (4:3)	12.1" TFT (4:3)	15" TFT (4:3)
	Backlight	CCFL	CCFL	LED	CCFL	LED	LED
	Resolution	800 x 600	800 x 600	1024 x 768	800 x 600	1024 x 768	1024 x 768
	Colors	16.2 M	16.2 M	16.2 M	16.2 M	16.2 M	16.2 M
	Luminance (cd/m ²)	450	230	350	400	500	400
	Contrast Ratio	600:1	500:1	1200:1	600:1	700:1	700:1
	Viewing Angle (H/V°)	150/150	140/120	176/176	160/120	160/160	160/160
	MTBF (hrs)	50,000	50,000	50,000	50,000	50,000	50,000
Touch Screen	5-wire resistive	5-wire resistive	5-wire resistive	5-wire resistive	5-wire resistive	5-wire resistive	
Dimension (W x H x D, mm)		270.7 x 207 x 71	302 x 224 x 70.2	302 x 224 x 70.2	349.4x263.9x70	349.4x263.9x70	400.9x303.7x71
Weight (kg)		3	4	4	5.5	5.5	6.5
OSD Controller		Yes (rear)	Yes (rear)	Yes (rear)	Yes (rear)	Yes (rear)	Yes (rear)

Model Name	12V	SM-ZJD15RF	SM-ZJL17RF	SM-ZJD17RF	SM-ZJL19RF	SM-ZJD21RF
	19~36V	-	SM-ZJL17RW	-	SM-ZJL19RW	SM-ZJD21RW
Display	Size / Aspect Ratio	15.6" TFT (16:9)	17" TFT (4:3)	17.3" TFT (16:9)	19" TFT (4:3)	21.5" TFT (16:9)
	Backlight	LED	LED	LED	LED	LED
	Resolution	1366 x 768	1280 x 1024	1920 x 1080	1280 x 1024	1920 x 1080
	Colors	16.7 M	16.7 M	16.7 M	16.7 M	16.7 M
	Luminance (cd/m ²)	300	350	400	250	300
	Contrast Ratio	500:1	1000:1	600:1	1000:1	5000:1
	Viewing Angle (H/V°)	170/160	140/170	160/140	170/160	178/178
	MTBF (hrs)	50,000	50,000	50,000	50,000	50,000
Touch Screen	5-wire resistive	5-wire resistive	5-wire resistive	5-wire resistive	5-wire resistive	
Dimension (W x H x D, mm)		454 x 272.4 x 74.3	453.5 x 351.9 x 71	TBD	487 x 376.8 x 75	581.3 x 337.2 x 73.6
Weight (kg)		7	8.5	8.5	9	10
OSD Controller		Yes (rear)	Yes (rear)	Yes (rear)	Yes (rear)	Yes (rear)

HM Series Sunlight Readable Monitor



Touch Function



IP65 front bezel,
Waterproof gasket (optional)



Waterproof Design



Housing Design

Aluminum front bezel + metal chassis



OSD Controller

Rear side



Sunlight Readable

Up to 1600 nit

Power Supply	DC in 12V external power adapter (DC in 19V ~ 36V optional for 17", 19" & 21.5")
I/O Ports (Default)	1 x VGA, 1 x DVI, 1 x USB or RS232 for resistive touch screen, 1 x Power terminal block (15", 21.5")
I/O Ports (Optional)	1 x HDMI (15" ~ 21.5")
Operation Temperature	0°C ~ 45°C
Storage Temperature	-10°C ~ 70°C
Relative Humidity	0% ~ 95% non-condensing
OS Support	Win 7 Pro, Embedded 7, Win XP Pro, Embedded XP
Installation	Panel mount & VESA mount 75 x 75 mm (10.4" & 12.1") / 100 x 100 mm (15" ~ 21.5")
Optional Items	Waterproof gasket, None touch screen, Open frame, Stainless front bezel

Model Name		HM-ZJL10RF (12V)		HM-ZJS12RF (12V)			HM-ZJL15RF (12V)		
Display	Size / Aspect Ratio	10.4" TFT (4:3)		12.1" TFT (4:3)			15" TFT (4:3)		
	Resolution	800 x 600		1024 x 768			1024 x 768		
	Colors	262 K	262 K	16.2M			16.7M	16.2M	16.7M
	Luminance (cd/m2)	1600	1600	1600			1600	1000	800
	Contrast Ratio	400:1	400:1	700:1			700:1	700:1	700:1
	Viewing Angle (H/V°)	130/110	130/110	160/160			160/160	160/160	160/160
	MTBF (hrs)	70,000		70,000			70,000		
Touch Screen	5-wire resistive		5-wire resistive			5-wire resistive			
Dimension (W x H x D, mm)		302 x 224 x 70.2		349.4 x 263.9 x 70			400.9 x 303.7 x 71		
Weight (kg)		4		5.5			6.5		
OSD Controller		Yes (rear)		Yes (rear)			Yes (rear)		

Model Name		HM-ZJL17RF (12V)			HM-ZJL19RF (12V)			HM-ZJD21RF (12V)		
		HM-ZJL17RW (19~36V)			HM-ZJL19RW (19~36V)			HM-ZJD21RW (19~36V)		
Display	Size / Aspect Ratio	17" TFT (4:3)			19" TFT (4:3)			21.5" TFT (16:9)		
	Resolution	1280 x 1024			1280 x 1024			1920 x 1080		
	Colors	16.7M	16.7M	16.7M	16.7 M	16.7 M	16.7 M	16.7M	16.7M	16.7M
	Luminance (cd/m2)	1600	1000	800	1600	1000	800	1600	1200	1000
	Contrast Ratio	1000:1	1000:1	1000:1	1000:1	1000:1	1000:1	900:1	1100:1	1000:1
	Viewing Angle (H/V°)	170/170	160/160	170/170	170/160	160/170	170/160	170/160	170/160	170/160
	MTBF (hrs)	70,000			70,000			70,000		
Touch Screen	5-wire resistive			5-wire resistive			5-wire resistive			
Dimension (W x H x D, mm)		453.5 x 351.9 x 71			487 x 376.8 x 75			581.3 x 337.2 x 73.6		
Weight (kg)		8.5			9			10		
OSD Controller		Yes (rear)			Yes (rear)			Yes (rear)		

DM Series Wide Temperature Monitor



-  Touch Function
 -  Waterproof Design
 -  Housing Design
 -  OSD Controller
 -  Heat/cold-resistant
-  IP65 front bezel,
Waterproof gasket (optional)
 - Aluminum front bezel + metal chassis
 - Rear side
 - 20°C ~ 55°C

Power Supply	DC in 12V external power adapter (DC in 19V ~ 36V optional for 17" & 19")
I/O Ports (Default)	1 x VGA, 1 x DVI, 1 x USB or RS232 for resistive touch screen, 1 x Power terminal block (15")
I/O Ports (Optional)	1 x HDMI (15" ~ 19")
Op. Temp. (Monitor)	-20°C ~ 55°C
Op. Temp. (Adapter)	-20°C ~ 50°C
Storage Temperature	-10°C ~ 70°C
Relative Humidity	0% ~ 95% non-condensing
OS Support	Win 7 Pro, Embedded 7, Win XP Pro, Embedded XP
Installation	Panel mount & VESA mount 75 x 75 mm (10.4" & 12.1") / 100 x 100 mm (15" ~ 19")
Optional Items	Waterproof gasket, None touch screen, Open frame, Stainless front bezel

Model Name		DM-ZJR10RF (12V)	DM-ZJS10RF (12V)	DM-ZJR12RF (12V)	DM-ZJS12RF (12V)
Display	Size / Aspect Ratio	10.4" TFT (4:3)	10.4" TFT (4:3)	12.1" TFT (4:3)	12.1" TFT (4:3)
	Resolution	800 x 600	1024 x 768	800 x 600	1024 x 768
	Colors	16.2 M	16.2 M	16.2 M	16.2 M
	Luminance (cd/m2)	230	350	450	500
	Contrast Ratio	500:1	1200:1	700:1	700:1
	Viewing Angle (H/V°)	140/120	176/176	160/150	160/160
	MTBF (hrs)	50,000	50,000	50,000	50,000
	Touch Screen	5-wire resistive	5-wire resistive	5-wire resistive	5-wire resistive
Dimension (W x H x D, mm)		302 x 224 x 70.2	302 x 224 x 70.2	349.4 x 263.9 x 70	349.4 x 263.9 x 70
Weight (kg)		4	4	5.5	5.5
OSD Controller		Yes (rear)	Yes (rear)	Yes (rear)	Yes (rear)

Model Name		DM-ZJL15RF (12V)	DM-ZJL17RF (12V) DM-ZJL17RW (19~36V)	DM-ZJL19RF (12V) DM-ZJL19RW (19~36V)
Display	Size / Aspect Ratio	15" TFT (4:3)	17" TFT (4:3)	19" TFT (4:3)
	Resolution	1024 x 768	1280 x 1024	1280 x 1024
	Colors	16.2 M	16.7 M	16.7 M
	Luminance (cd/m2)	400	350	350
	Contrast Ratio	700:1	1000:1	1000:1
	Viewing Angle (H/V°)	160/160	140/170	160/150
	MTBF (hrs)	50,000	50,000	50,000
	Touch Screen	5-wire resistive	5-wire resistive	5-wire resistive
Dimension (W x H x D, mm)		400.9 x 303.7 x 71	453.5 x 351.9 x 71	487 x 376.8 x 75
Weight (kg)		6.5	8.5	9
OSD Controller		Yes (rear)	Yes (rear)	Yes (rear)

LM Series Wide Temperature Sunlight Readable Monitor



Touch Function



IP65 front bezel,
Waterproof gasket (optional)



Waterproof Design



Housing Design

Aluminum front bezel + metal chassis



OSD Controller

Rear side



Heat/cold-resistant

-20°C ~ 55°C



Sunlight Readable

Up to 1600 nit

Power Supply DC in 12V external power adapter (DC in 19V ~ 36V optional for 17")

I/O Ports (Default) 1 x VGA, 1 x DVI, 1 x USB or RS232 for resistive touch screen, 1 x Power terminal block (15")

I/O Ports (Optional) 1 x HDMI

Op. Temp. (Monitor) -20°C ~ 55°C

Op. Temp. (Adapter) -20°C ~ 50°C

Storage Temperature -25°C ~ 70°C

Relative Humidity 0% ~ 95% non-condensing

OS Support Win 7 Pro, Embedded 7, Win XP Pro, Embedded XP

Installation Panel mount & VESA mount 75 x 75 mm (10.4" & 12.1") / 100 x 100 mm (15" & 17")

Optional Items Waterproof gasket, None touch screen, Open frame, Stainless front bezel

Model Name	12V	LM-ZJL10RF		LM-ZJS10RF		LM-ZJL12RF	
	19~36V	-		-		-	
Display	Size / Aspect Ratio	10.4" TFT (4:3)		10.4" TFT (4:3)		12.1" TFT (4:3)	
	Backlight	LED		LED		LED	
	Resolution	800 x 600		1024 x 768		800 x 600	
	Colors	262 K	262 K	262 K	16.2 M	262 K	
	Luminance (cd/m2)	1600	1000	1000	800	1000	
	Contrast Ratio	400:1	400:1	600:1	1200:1	1000:1	
	Viewing Angle (H/V°)	130/110	130/110	178/178	176/176	178/178	
	MTBF (hrs)	70,000		70,000		70,000	
Touch Screen	5-wire resistive		5-wire resistive		5-wire resistive		
Dimension (W x H x D, mm)	302 x 224 x 70.2		302 x 224 x 70.2		349.4 x 263.9 x 70		
Weight (kg)	4		4		5.5		
OSD Controller	Yes (rear)		Yes (rear)		Yes (rear)		

Model Name	12V	LM-ZJS12RF			LM-ZJL15RF			LM-ZJL17RF
	19~36V	-			-			LM-ZJL17RW
Display	Size / Aspect Ratio	12.1" TFT (4:3)			15" TFT (4:3)			17" TFT (4:3)
	Backlight	LED			LED			LED
	Resolution	1024 x 768			1024 x 768			1280 x 1024
	Colors	16.2 M	262 K	16.2 M	16.7 M	16.2 M	16.7 M	16.7 M
	Luminance (cd/m2)	1600	1000	800	1600	1000	800	1600
	Contrast Ratio	700:1	700:1	700:1	700:1	700:1	700:1	1000:1
	Viewing Angle (H/V°)	160/160	160/160	160/160	160/160	160/160	160/160	170/160
	MTBF (hrs)	70,000			70,000			70,000
Touch Screen	5-wire resistive			5-wire resistive			5-wire resistive	
Dimension (W x H x D, mm)	349.4 x 263.9 x 70			400.9 x 303.7 x 71			453.5 x 351.9 x 71	
Weight (kg)	5.5			6.5			8.5	
OSD Controller	Yes (rear)			Yes (rear)			Yes (rear)	

TM Series Multi Touch Monitor



Touch Function



Waterproof Design



Housing Design



OSD Controller



IP65 front bezel,
Waterproof gasket (optional)

Aluminum front bezel + metal chassis

Rear side

Power Supply	DC in 12V external power adapter
I/O Ports (Default)	1 x VGA, 1 x DVI, 1 x USB or RS232 for touch screen, 1 x Power terminal block
I/O Ports (Optional)	1 x HDMI (15" ~ 21.5")
Operation Temperature	0°C ~ 45°C
Storage Temperature	-10°C ~ 70°C
Relative Humidity	0% ~ 95% non-condensing
OS Support	Win 7 Pro, Embedded 7, Win XP Pro, Embedded XP
Installation	Clip mount, Panel mount & VESA mount 75 x 75 mm (10.4" & 12.1") / 100 x 100 mm (15" ~ 21.5")
Optional Items	Waterproof gasket, Open frame, Stainless front bezel, Mounting clips

Model Name		TM-ZJR10DF (2pt PCT)	TM-ZJS10DF (2pt PCT)	TM-ZJR12DF (2pt PCT)	TM-ZJS12DF (2pt PCT)	TM-ZJL15QF (4pt PCT) TM-ZJL15RF (resistive)
Display	Size / Aspect Ratio	10.4" TFT (4:3)	10.4" TFT (4:3)	12.1" TFT (4:3)	12.1" TFT (4:3)	15" TFT (4:3)
	Backlight	CCFL	LED	CCFL	LED	LED
	Resolution	800 x 600	1024 x 768	800 x 600	1024 x 768	1024 x 768
	Colors	16.2 M	16.2 M	16.2 M	16.2 M	16.2 M
	Luminance (cd/m2)	230	350	400	500	400
	Contrast Ratio	500:1	1200:1	600:1	700:1	700:1
	Viewing Angle (H/V°)	140/120	176/176	160/120	160/160	160/160
	MTBF (hrs)	50,000	50,000	50,000	50,000	50,000
Touch Screen	2pt PCT	2pt PCT	2pt PCT	2pt PCT	4pt PCT / 5-w resist.	
Dimension (W x H x D, mm)		TBD	TBD	TBD	TBD	441 x 322 x 68.8
Weight (kg)		4	4	5.5	5.5	7
OSD Controller		Yes (rear)	Yes (rear)	Yes (rear)	Yes (rear)	Yes (rear)

Model Name		TM-ZJD15QF (4pt PCT)	TM-ZJR17QF (4pt PCT) TM-ZJR17RF (resistive)	TM-ZJL17QF (4pt PCT) TM-ZJL17RF (resistive)	TM-ZJL19QF (4pt PCT)	TM-ZJD21QF (4pt PCT) TM-ZJD21ZF (10pt PCT)
Display	Size / Aspect Ratio	15.6" TFT (16:9)	17" TFT (4:3)	17" TFT (4:3)	19" TFT (4:3)	21.5" TFT (16:9)
	Backlight	LED	CCFL	LED	LED	LED
	Resolution	1366 x 768	1280 x 1024	1280 x 1024	1280 x 1024	1920 x 1080
	Colors	16.7 M	16.7 M	16.7 M	16.7 M	16.7 M
	Luminance (cd/m2)	300	300	350	250	300
	Contrast Ratio	500:1	800:1	1000:1	1000:1	5000:1
	Viewing Angle (H/V°)	170/160	140/125	140/170	170/160	178/178
	MTBF (hrs)	50,000	50,000	50,000	50,000	50,000
Touch Screen	4pt PCT	4pt PCT / 5-w resist.	4pt PCT / 5-w resist.	4pt PCT	4/10pt PCT	
Dimension (W x H x D, mm)		463.6 x 298.6 x 71.8	483 x 376 x 70.8	483 x 376 x 70.8	528 x 414.4 x 71.8	607 x 395 x 72.8
Weight (kg)		7.5	8.5	8.5	9.5	10.5
OSD Controller		Yes (rear)	Yes (rear)	Yes (rear)	Yes (rear)	Yes (rear)

UM Series Sunlight Readable Multi Touch Monitor



Touch Function



IP65 front bezel,
Waterproof gasket (optional)



Waterproof Design



Housing Design

Aluminum front bezel + metal chassis



OSD Controller

Rear side



Sunlight Readable

Up to 1600 nit

Power Supply DC in 12V external power adapter

I/O Ports (Default) 1 x VGA, 1 x DVI, 1 x USB or RS232 for PCT touch screen, 1 x Power terminal block

I/O Ports (Optional) 1 x HDMI (15" ~ 21.5")

Operation Temperature 0°C ~ 45°C

Storage Temperature -10°C ~ 70°C

Relative Humidity 0% ~ 95% non-condensing

OS Support Win 7 Pro, Embedded 7, Win XP Pro, Embedded XP

Installation Clip mount, Panel mount & VESA mount 75 x 75 mm (10.4" & 12.1") / 100 x 100 mm (15" ~ 21.5")

Optional Items Waterproof gasket, Open frame, Stainless front bezel, Mounting clips

Model Name		UM-ZJL10DF (2pt PCT)		UM-ZJS10DF (2pt PCT)		UM-ZJL12DF (2pt PCT)			UM-ZJS12DF (2pt PCT)		
Display	Size / Aspect Ratio	10.4" TFT (4:3)		10.4" TFT (4:3)		12.1" TFT (4:3)			12.1" TFT (4:3)		
	Resolution	800 x 600		1024 x 768		800 x 600			1024 x 768		
	Colors	262K	262K	262K	16.2M	262K			16.2M		
	Luminance (cd/m2)	1600	1000	1000	800	1000			1600		
	Contrast Ratio	400:1	400:1	600:1	1200:1	1000:1			700:1		
	Viewing Angle (H/V°)	130/110	130/110	178/178	176/176	178/178			160/160		
	MTBF (hrs)	70,000		70,000		70,000			70,000		
	Touch Screen	2pt PCT		2pt PCT		2pt PCT			2pt PCT		
Dimension (W x H x D, mm)		TBD		TBD		TBD			TBD		
Weight (kg)		4		4		5.5			5.5		
OSD Controller		Yes (rear)		Yes (rear)		Yes (rear)			Yes (rear)		

Model Name		UM-ZJL15DF (2pt PCT) UM-ZJL15QF (4pt PCT) UM-ZJL15RF (resistive)			UM-ZJL17DF (2pt PCT) UM-ZJL17QF (4pt PCT)			UM-ZJL19DF (2pt PCT) UM-ZJL19QF (4pt PCT)			UM-ZJD21QF (4pt PCT) UM-ZJD21ZF (10pt PCT)		
Display	Size / Aspect Ratio	15" TFT (4:3)			17" TFT (4:3)			19" TFT (4:3)			21.5" TFT (16:9)		
	Resolution	1024 x 768			1280 x 1024			1280 x 1024			1920 x 1080		
	Colors	16.2M	16.2M	16.2M	16.7M	16.7M	16.7M	16.7 M	16.7 M	16.7 M	16.7 M	16.7 M	16.7 M
	Luminance (cd/m2)	800	1000	800	1600	1000	800	1600	1000	800	1600	1200	1000
	Contrast Ratio	1200:1	700:1	1200:1	1000:1	1000:1	1000:1	1000:1	1000:1	1000:1	900:1	1100:1	1000:1
	Viewing Angle (H/V°)	176/176	160/160	176/176	170/170	160/160	170/170	170/160	170/160	170/160	170/160	170/160	170/160
	MTBF (hrs)	70,000			70,000			70,000			70,000		
	Touch Screen	2/4pt PCT / 5-W resistive			2/4pt PCT			2/4pt PCT			4/10-point PCT		
Dimension (W x H x D, mm)		441 x 322 x 68.8			483 x 376 x 70.8			528 x 414.4 x 71.8			607 x 395 x 72.8		
Weight (kg)		7			8.5			9.5			10.5		
OSD Controller		Yes (rear)			Yes (rear)			Yes (rear)			Yes (rear)		

EM Series Wide Temperature Multi Touch Monitor



Touch Function



Waterproof Design

IP65 front bezel,
Waterproof gasket (optional)



Housing Design

Aluminum front bezel + metal chassis



OSD Controller

Rear side



Heat/cold-resistant

-20°C ~ 55°C

Power Supply DC in 12V external power adapter

I/O Ports (Default) 1 x VGA, 1 x DVI, 1 x USB or RS232 for PCT touch screen, 1 x Power terminal block

I/O Ports (Optional) 1 x HDMI (15" ~ 19")

Op. Temp. (Monitor) -20°C ~ 55°C

Op. Temp. (Adapter) -20°C ~ 50°C

Storage Temperature -10°C ~ 70°C

Relative Humidity 0% ~ 95% non-condensing

OS Support Win 7 Pro, Embedded 7, Win XP Pro, Embedded XP

Installation Clip mount, Panel mount & VESA mount 75 x 75 mm (10.4" & 12.1") / 100 x 100 mm (15" ~ 19")

Optional Items Waterproof gasket, Open frame, Stainless front bezel, Mounting clips

Model Name		EM-ZJS10DF (2pt PCT)	EM-ZJS12DF (2pt PCT)	EM-ZJL15DF (2pt PCT)	EM-ZJL17DF (2pt PCT)	EM-ZJL19DF (2pt PCT)
				EM-ZJL15QF (4pt PCT)	EM-ZJL17QF (4pt PCT)	EM-ZJL19QF (4pt PCT)
Display	Size / Aspect Ratio	10.4" TFT (4:3)	12.1" TFT (4:3)	15" TFT (4:3)	17" TFT (4:3)	19" TFT (4:3)
	Resolution	1024 x 768	1024 x 768	1024 x 768	1280 x 1024	1280 x 1024
	Colors	16.2 M	16.2 M	16.2 M	16.7 M	16.7 M
	Luminance (cd/m2)	350	500	400	350	350
	Contrast Ratio	1200:1	700:1	700:1	1000:1	1000:1
	Viewing Angle (H/V°)	176/176	160/160	160/160	140/170	160/150
	MTBF (hrs)	50,000	50,000	50,000	50,000	50,000
	Touch Screen	2-point PCT	2-point PCT	2/4pt PCT / resistive	2/4-point PCT	2/4-point PCT
Dimension (W x H x D, mm)		TBD	TBD	441 x 322 x 68.8	483 x 376 x 70.8	528 x 414.4 x 71.8
Weight (kg)		4	5.5	7	8.5	9.5
OSD Controller		Yes (rear)	Yes (rear)	Yes (rear)	Yes (rear)	Yes (rear)

Highlights

IP65 compliant aluminum / stainless steel front bezel
to provide basic waterproof protection against
water spary from the front side

Hairy brushed finish
to deliver an aesthetic appearance





Seamless flat-bezel design between bezel and panel
to decrease water / dust accumulation and
to facilitate cleaning / maintenance



TM / UM / EM / VM Series

VM Series Wide Temperature Sunlight Readable Multi Touch Monitor



-  Touch Function
 
-  Waterproof Design
 IP65 front bezel,
Waterproof gasket (optional)
-  Housing Design
 Aluminum front bezel + metal chassis
-  OSD Controller
 Rear side
-  Heat/cold-resistant
 -20°C ~ 55°C
-  Sunlight Readable
 Up to 1600 nit



Power Supply	DC in 12V external power adapter
I/O Ports (Default)	1 x VGA, 1 x DVI, 1 x USB or RS232 for PCT touch screen, 1 x Power terminal block
I/O Ports (Optional)	1 x HDMI (15" & 17")
Op. Temp. (Monitor)	-20°C ~ 55°C
Op. Temp. (Adapter)	-20°C ~ 50°C
Storage Temperature	-10°C ~ 70°C
Relative Humidity	0% ~ 95% non-condensing
OS Support	Win 7 Pro, Embedded 7, Win XP Pro, Embedded XP
Installation	Clip mount, Panel mount & VESA mount 75 x 75 mm (10.4" & 12.1") / 100 x 100 mm (15" & 17")
Optional Items	Waterproof gasket, Open frame, Stainless front bezel, Mounting clips

Model Name		VM-ZJK10DF <small>(2pt PCT)</small>		VM-ZJK12DF <small>(2pt PCT)</small>		VM-ZJL15DF <small>(2pt PCT)</small> VM-ZJL15QF <small>(4pt PCT)</small> VM-ZJL15RF <small>(resistive)</small>			VM-ZJL17DF <small>(2pt PCT)</small> VM-ZJL17QF <small>(4pt PCT)</small>	
Display	Size / Aspect Ratio	10.4" TFT (4:3)		12.1" TFT (4:3)		15" TFT (4:3)			17" TFT (4:3)	
	Resolution	1024 x 768		1024 x 768		1024 x 768			1280 x 1024	
	Colors	262K	16.2M	16.2M	16.7M	16.2M	16.7M	16.7M	16.7M	16.7M
	Luminance (cd/m2)	1000	800	1600	1600	1000	800	1600	1600	1600
	Contrast Ratio	600:1	1200:1	700:1	700:1	700:1	700:1	700:1	1000:1	1000:1
	Viewing Angle (H/V°)	178/178	176/176	160/160	160/160	160/160	160/160	160/160	170/160	170/160
	MTBF (hrs)	70,000		70,000		70,000			70,000	
	Touch Screen	2pt PCT		2pt PCT		2/4pt PCT / 5-W resistive			2/4pt PCT	
Dimension (W x H x D, mm)	TBD		TBD		441 x 322 x 68.8			483 x 376 x 70.8		
Weight (kg)	4		5.5		7			8.5		
OSD Controller	Yes (rear)		Yes (rear)		Yes (rear)			Yes (rear)		

Highlights



TM / UM / EM / VM Series

-  7H hardness anti-scratch panel surface
to avoid touch function failure due to scratch
-  Oil- & water-stain-proof panel surface
to ensure touch sensitivity
-  Enhanced PCT touch panel
to enable input with glove which is necessary in some applications such as semiconductor / panel clean room, PCB or metal processing

RM Series Rack Mount Monitor



Touch Function



IP65 front bezel



Waterproof Design



Housing Design

Aluminum front bezel + metal chassis



OSD Controller

Rear side

Power Supply	DC in 12V external power adapter (DC in 19V ~ 36V optional for 17" & 19")
I/O Ports (Default)	1 x VGA, 1 x DVI, 1 x USB or RS232 for resistive touch screen, 1 x Power terminal block (15")
I/O Ports (Optional)	1 x HDMI (15" ~ 19")
Operation Temperature	0°C ~ 45°C
Storage Temperature	-10°C ~ 70°C
Relative Humidity	0% ~ 95% non-condensing
OS Support	Win 7 Pro, Embedded 7, Win XP Pro, Embedded XP
Installation	19" rack mount & VESA mount 75 x 75 mm (10.4" & 12.1") / 100 x 100 mm (15" ~ 19")
Optional Items	None touch screen

Model Name		12V 19~36V	RM-ZJR10RF	RM-ZJS10RF	RM-ZJR12RF	RM-ZJS12RF
Display	Size / Aspect Ratio		10.4" TFT (4:3)	10.4" TFT (4:3)	12.1" TFT (4:3)	12.1" TFT (4:3)
	Backlight		CCFL	LED	CCFL	LED
	Resolution		800 x 600	1024 x 768	800 x 600	1024 x 768
	Colors		16.2 M	16.2 M	16.2 M	16.2 M
	Luminance (cd/m2)		230	350	400	500
	Contrast Ratio		500:1	1200:1	600:1	700:1
	Viewing Angle (H/V°)		140/120	176/176	160/120	160/160
	MTBF (hrs)		50,000	50,000	50,000	50,000
Touch Screen		5-wire resistive	5-wire resistive	5-wire resistive	5-wire resistive	
Dimension (W x H x D, mm)			483 x 224 x 70	483 x 224 x 70	483 x 263.9 x 70	483 x 263.9 x 70
Weight (kg)			5	5	6	6
OSD Controller			Yes (rear)	Yes (rear)	Yes (rear)	Yes (rear)

Model Name		12V 19~36V	RM-ZJL15RF	RM-ZJR17RF RM-ZJR17RW	RM-ZJL17RF RM-ZJL17RW	RM-ZJL19RF RM-ZJL19RW
Display	Size / Aspect Ratio		15" TFT (4:3)	17" TFT (4:3)	17" TFT (4:3)	19" TFT (4:3)
	Backlight		LED	CCFL	LED	LED
	Resolution		1024 x 768	1280 x 1024	1280 x 1024	1280 x 1024
	Colors		16.2 M	16.7 M	16.7 M	16.7 M
	Luminance (cd/m2)		400	300	350	250
	Contrast Ratio		700:1	800:1	1000:1	1000:1
	Viewing Angle (H/V°)		160/160	140/125	140/170	170/160
	MTBF (hrs)		50,000	50,000	50,000	50,000
Touch Screen		5-wire resistive	5-wire resistive	5-wire resistive	5-wire resistive	
Dimension (W x H x D, mm)			483 x 303.7 x 70	483 x 352 x 70	483 x 352 x 70	483 x 376.8 x 70
Weight (kg)			7.5	9.5	9.5	10.5
OSD Controller			Yes (rear)	Yes (rear)	Yes (rear)	Yes (rear)

GM Series Sunlight Readable Rack Mount Monitor



-  Touch Function  IP65 front bezel
-  Waterproof Design  Aluminum front bezel + metal chassis
-  Housing Design  Rear side
-  OSD Controller  Up to 1600 nit
-  Sunlight Readable



Power Supply	DC in 12V external power adapter (DC in 19V ~ 36V optional for 17" & 19")
I/O Ports (Default)	1 x VGA, 1 x DVI, 1 x USB or RS232 for resistive touch screen, 1 x Power terminal block (15")
I/O Ports (Optional)	1 x HDMI (15" ~ 19")
Operation Temperature	0°C ~ 45°C
Storage Temperature	-10°C ~ 70°C
Relative Humidity	0% ~ 95% non-condensing
OS Support	Win 7 Pro, Embedded 7, Win XP Pro, Embedded XP
Installation	19" rack mount & VESA mount 75 x 75 mm (10.4" & 12.1") / 100 x 100 mm (15" ~ 19")
Optional Items	None touch screen

Model Name		GM-ZJL10RF ^(12V)		GM-ZJS10RF ^(12V)		GM-ZJL12RF ^(12V)		GM-ZJS12RF ^(12V)	
Display	Size / Aspect Ratio	10.4" TFT (4:3)		10.4" TFT (4:3)		12.1" TFT (4:3)		12.1" TFT (4:3)	
	Resolution	800 x 600		1024 x 768		800 x 600		1024 x 768	
	Colors	262K	262K	262K	16.2M	262K		16.2M	
	Luminance (cd/m2)	1600	1000	1000	800	1000		1600	
	Contrast Ratio	400:1	400:1	600:1	1200:1	1000:1		700:1	
	Viewing Angle (H/V°)	130/110	130/110	178/178	176/176	178/178		160/160	
	MTBF (hrs)	70,000		70,000		70,000		70,000	
	Touch Screen	5-wire resistive		5-wire resistive		5-wire resistive		5-wire resistive	
Dimension (W x H x D, mm)		483 x 224 x 70		483 x 224 x 70		483 x 263.9 x 70		483 x 263.9 x 70	
Weight (kg)		5		5		6		6	
OSD Controller		Yes (rear)		Yes (rear)		Yes (rear)		Yes (rear)	

Model Name		GM-ZJL15RF ^(12V)			GM-ZJL17RF ^(12V) GM-ZJL17RW ^(19~36V)			GM-ZJL19RF ^(12V) GM-ZJL19RW ^(19~36V)		
Display	Size / Aspect Ratio	15" TFT (4:3)			17" TFT (4:3)			19" TFT (4:3)		
	Resolution	1024 x 768			1280 x 1024			1280 x 1024		
	Colors	16.7M	16.2M	16.7M	16.7M	16.7M	16.7M	16.7 M	16.7 M	16.7 M
	Luminance (cd/m2)	1600	1000	800	1600	1000	800	1600	1000	800
	Contrast Ratio	700:1	700:1	700:1	1000:1	1000:1	1000:1	1000:1	1000:1	1000:1
	Viewing Angle (H/V°)	160/160	160/160	160/160	170/170	160/160	170/170	170/160	160/170	170/160
	MTBF (hrs)	70,000			70,000			70,000		
	Touch Screen	5-wire resistive			5-wire resistive			5-wire resistive		
Dimension (W x H x D, mm)		483 x 303.7 x 70			483 x 352 x 70			483 x 376.8 x 70		
Weight (kg)		7.5			9.5			10.5		
OSD Controller		Yes (rear)			Yes (rear)			Yes (rear)		

FM Series Wide Temperature Rack Mount Monitor







-  Touch Function
  IP65 front bezel
-  Waterproof Design
 Aluminum front bezel + metal chassis
-  Housing Design
 Rear side
-  OSD Controller
 -20°C ~ 55°C
-  Heat/cold-resistant

Power Supply	DC in 12V external power adapter (DC in 19V ~ 36V optional for 17" & 19")
I/O Ports (Default)	1 x VGA, 1 x DVI, 1 x USB or RS232 for resistive touch screen, 1 x Power terminal block (15")
I/O Ports (Optional)	1 x HDMI (15" ~ 19")
Op. Temp. (Monitor)	-20°C ~ 55°C
Op. Temp. (Adapter)	-20°C ~ 50°C
Storage Temperature	-10°C ~ 70°C
Relative Humidity	0% ~ 95% non-condensing
OS Support	Win 7 Pro, Embedded 7, Win XP Pro, Embedded XP
Installation	19" rack mount & VESA mount 75 x 75 mm (10.4" & 12.1") / 100 x 100 mm (15" ~ 19")
Optional Items	None touch screen

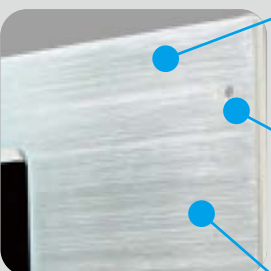
Model Name		FM-ZJS10RF	FM-ZJS12RF	FM-ZJL15RF	FM-ZJL17RF	FM-ZJL19RF
		(12V)	(12V)	(12V)	(12V)	(12V)
Display	Size / Aspect Ratio	10.4" TFT (4:3)	12.1" TFT (4:3)	15" TFT (4:3)	17" TFT (4:3)	19" TFT (4:3)
	Resolution	1024 x 768	1024 x 768	1024 x 768	1280 x 1024	1280 x 1024
	Colors	16.2 M	16.2 M	16.2 M	16.7 M	16.7 M
	Luminance (cd/m2)	350	500	400	350	350
	Contrast Ratio	1200:1	700:1	700:1	1000:1	1000:1
	Viewing Angle (H/V°)	176/176	160/160	160/160	140/170	160/150
	MTBF (hrs)	50,000	50,000	50,000	50,000	50,000
	Touch Screen	5-wire resistive	5-wire resistive	5-wire resistive	5-wire resistive	5-wire resistive
Dimension (W x H x D, mm)		483 x 224 x 70	483 x 263.9 x 70	483 x 303.7 x 70	483 x 352 x 70	483 x 376.8 x 70
Weight (kg)		5	6	7.5	9.5	10.5
OSD Controller		Yes (rear)	Yes (rear)	Yes (rear)	Yes (rear)	Yes (rear)

Highlights

- 
-  IP65 compliant aluminum / stainless steel front bezel to provide basic waterproof protection against water spary from the front side
 -  Standard design to screw to the rack cabinet
 -  Hairy brushed finish to deliver an aesthetic appearance
- RM / GM / FM / BM Series

BM Series Wide Temperature Sunlight Readable Rack Mount Monitor



-  Touch Function
  IP65 front bezel
-  Waterproof Design
  Aluminum front bezel + metal chassis
-  Housing Design
  Rear side
-  OSD Controller
  -20°C ~ 55°C
-  Heat/cold-resistant
  Up to 1600 nit
-  Sunlight Readable
  None touch screen

Power Supply	DC in 12V external power adapter (DC in 19V ~ 36V optional for 17")
I/O Ports (Default)	1 x VGA, 1 x DVI, 1 x USB or RS232 for resistive touch screen, 1 x Power terminal block (15")
I/O Ports (Optional)	1 x HDMI (15" & 17")
Op. Temp. (Monitor)	-20°C ~ 55°C
Op. Temp. (Adapter)	-20°C ~ 50°C
Storage Temperature	-10°C ~ 70°C
Relative Humidity	0% ~ 95% non-condensing
OS Support	Win 7 Pro, Embedded 7, Win XP Pro, Embedded XP
Installation	19" rack mount & VESA mount 75 x 75 mm (10.4" & 12.1") / 100 x 100 mm (15" & 17")
Optional Items	None touch screen

Model Name		BM-ZJS10RF (12V)	BM-ZJS12RF (12V)	BM-ZJL15RF (12V)	BM-ZJL17RF (12V)	BM-ZJL17RW (19~36V)			
Display	Size / Aspect Ratio	10.4" TFT (4:3)		12.1" TFT (4:3)		15" TFT (4:3)		17" TFT (4:3)	
	Resolution	1024 x 768		1024 x 768		1024 x 768		1280 x 1024	
	Colors	262K	16.2M	16.2M	16.7M	16.2M	16.7M	16.7M	
	Luminance (cd/m2)	1000	800	1600	1600	1000	800	1600	
	Contrast Ratio	600:1	1200:1	700:1	700:1	700:1	700:1	1000:1	
	Viewing Angle (H/V°)	178/178	176/176	160/160	160/160	160/160	160/160	170/160	
	MTBF (hrs)	70,000		70,000		70,000		70,000	
	Touch Screen	5-wire resistive		5-wire resistive		5-wire resistive		5-wire resistive	
Dimension (W x H x D, mm)		483 x 224 x 70		483 x 263.9 x 70		483 x 303.7 x 70		483 x 352 x 70	
Weight (kg)		5		6		7.5		9.5	
OSD Controller		Yes (rear)		Yes (rear)		Yes (rear)		Yes (rear)	

Highlights



19" rack mount system integration solution available
Kingdy RB Series

RM / GM / FM / BM / AM / CM / KM / QM Series

AM Series Rack Mount Multi Touch Monitor



Touch Function



Waterproof Design

IP65 front bezel



Housing Design

Aluminum front bezel + metal chassis



OSD Controller

Rear side

Power Supply	DC in 12V external power adapter
I/O Ports (Default)	1 x VGA, 1 x DVI, 1 x USB or RS232 for PCT touch screen, 1 x Power terminal block
I/O Ports (Optional)	1 x HDMI (15" ~ 19")
Operation Temperature	0°C ~ 45°C
Storage Temperature	-10°C ~ 70°C
Relative Humidity	0% ~ 95% non-condensing
OS Support	Win 7 Pro, Embedded 7, Win XP Pro, Embedded XP
Installation	19" rack mount & VESA mount 75 x 75 mm (10.4" & 12.1") / 100 x 100 mm (15" ~ 19")

Model Name	AM-ZJR10DF (2pt PCT)	AM-ZJS10DF (2pt PCT)	AM-ZJR12DF (2pt PCT)	AM-ZJS12DF (2pt PCT)
Display	Size / Aspect Ratio	10.4" TFT (4:3)	10.4" TFT (4:3)	12.1" TFT (4:3)
	Backlight	CCFL	LED	CCFL
	Resolution	800 x 600	1024 x 768	800 x 600
	Colors	16.2 M	16.2 M	16.2 M
	Luminance (cd/m2)	230	350	400
	Contrast Ratio	500:1	1200:1	600:1
	Viewing Angle (H/V°)	140/120	176/176	160/120
	MTBF (hrs)	50,000	50,000	50,000
Touch Screen	2pt PCT	2pt PCT	2pt PCT	2pt PCT
Dimension (W x H x D, mm)	TBD	TBD	TBD	TBD
Weight (kg)	5	5	6	6
OSD Controller	Yes (rear)	Yes (rear)	Yes (rear)	Yes (rear)

Model Name	AM-ZJL15QF (4pt PCT) AM-ZJL15RF (resistive)	AM-ZJR17QF (4pt PCT)	AM-ZJL17QF (4pt PCT)	AM-ZJL19QF (4pt PCT)
Display	Size / Aspect Ratio	15" TFT (4:3)	17" TFT (4:3)	17" TFT (4:3)
	Backlight	LED	CCFL	LED
	Resolution	1024 x 768	1280 x 1024	1280 x 1024
	Colors	16.2 M	16.7 M	16.7 M
	Luminance (cd/m2)	400	300	350
	Contrast Ratio	700:1	800:1	1000:1
	Viewing Angle (H/V°)	160/160	140/125	140/170
	MTBF (hrs)	50,000	50,000	50,000
Touch Screen	4pt PCT / 5-w resist.	4pt PCT	4pt PCT	4pt PCT
Dimension (W x H x D, mm)	TBD	TBD	TBD	TBD
Weight (kg)	7.5	9.5	9.5	10.5
OSD Controller	Yes (rear)	Yes (rear)	Yes (rear)	Yes (rear)

CM Series Sunlight Readable Rack Mount Multi Touch Monitor



Touch Function



Waterproof Design IP65 front bezel



Housing Design Aluminum front bezel + metal chassis



OSD Controller Rear side



Sunlight Readable Up to 1600 nit

Power Supply DC in 12V external power adapter

I/O Ports (Default) 1 x VGA, 1 x DVI, 1 x USB or RS232 for PCT touch screen, 1 x Power terminal block

I/O Ports (Optional) 1 x HDMI (15" ~ 19")

Operation Temperature 0°C ~ 45°C

Storage Temperature -10°C ~ 70°C

Relative Humidity 0% ~ 95% non-condensing

OS Support Win 7 Pro, Embedded 7, Win XP Pro, Embedded XP







Installation 19" rack mount & VESA mount 75 x 75 mm (10.4" & 12.1") / 100 x 100 mm (15" ~ 19")

Model Name		CM-ZJL10DF (2pt PCT)		CM-ZJS10DF (2pt PCT)		CM-ZJL12DF (2pt PCT)		CM-ZJS12DF (2pt PCT)	
Display	Size / Aspect Ratio	10.4" TFT (4:3)		10.4" TFT (4:3)		12.1" TFT (4:3)		12.1" TFT (4:3)	
	Resolution	800 x 600		1024 x 768		800 x 600		1024 x 768	
	Colors	262K	262K	262K	16.2M	262K		16.2M	
	Luminance (cd/m2)	1600	1000	1000	800	1000		1600	
	Contrast Ratio	400:1	400:1	600:1	1200:1	1000:1		700:1	
	Viewing Angle (H/V°)	130/110	130/110	178/178	176/176	178/178		160/160	
	MTBF (hrs)	70,000		70,000		70,000		70,000	
	Touch Screen	2pt PCT		2pt PCT		2pt PCT		2pt PCT	
Dimension (W x H x D, mm)		TBD		TBD		TBD		TBD	
Weight (kg)		5		5		6		6	
OSD Controller		Yes (rear)		Yes (rear)		Yes (rear)		Yes (rear)	

Model Name		CM-ZJL15DF (2pt PCT)			CM-ZJL17DF (2pt PCT)			CM-ZJL19DF (2pt PCT)		
		CM-ZJL15QF (4pt PCT)			CM-ZJL17QF (4pt PCT)			CM-ZJL19QF (4pt PCT)		
Display	Size / Aspect Ratio	15" TFT (4:3)			17" TFT (4:3)			19" TFT (4:3)		
	Resolution	1024 x 768			1280 x 1024			1280 x 1024		
	Colors	16.7M	16.2M	16.7M	16.7M	16.7M	16.7M	16.7M	16.7M	16.7M
	Luminance (cd/m2)	1600	1000	800	1600	1000	800	1600	1000	800
	Contrast Ratio	700:1	700:1	700:1	1000:1	1000:1	1000:1	1000:1	1000:1	1000:1
	Viewing Angle (H/V°)	160/160	160/160	160/160	170/170	160/160	170/170	170/160	170/160	170/160
	MTBF (hrs)	70,000			70,000			70,000		
	Touch Screen	2/4pt PCT			2/4pt PCT			2/4pt PCT		
Dimension (W x H x D, mm)		TBD			TBD			TBD		
Weight (kg)		7.5			9.5			10.5		
OSD Controller		Yes (rear)			Yes (rear)			Yes (rear)		

KM Series Wide Temperature Rack Mount Multi Touch Monitor







-  Touch Function
  IP65 front bezel
-  Waterproof Design
-  Housing Design
 Aluminum front bezel + metal chassis
-  OSD Controller
 Rear side
-  Heat/cold-resistant
 -20°C ~ 55°C

Power Supply	DC in 12V external power adapter
I/O Ports (Default)	1 x VGA, 1 x DVI, 1 x USB or RS232 for PCT touch screen, 1 x Power terminal block
I/O Ports (Optional)	1 x HDMI (15" ~ 19")
Op. Temp. (Monitor)	-20°C ~ 55°C
Op. Temp. (Adapter)	-20°C ~ 50°C
Storage Temperature	-10°C ~ 70°C
Relative Humidity	0% ~ 95% non-condensing
OS Support	Win 7 Pro, Embedded 7, Win XP Pro, Embedded XP
Installation	19" rack mount & VESA mount 75 x 75 mm (10.4" & 12.1") / 100 x 100 mm (15" ~ 19")

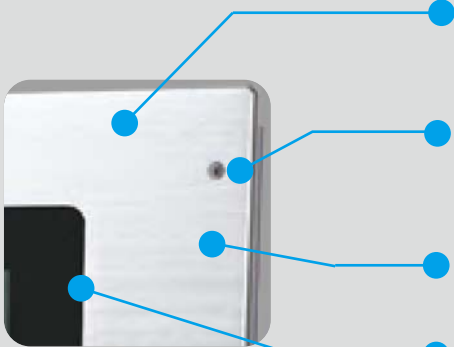





Model Name		KM-ZJS10DF (2pt PCT)	KM-ZJS12DF (2pt PCT)	KM-ZJL15DF (2pt PCT) KM-ZJL15QF (2pt PCT)	KM-ZJL17DF (2pt PCT) KM-ZJL17QF (4pt PCT)	KM-ZJL19DF (2pt PCT) KM-ZJL19QF (4pt PCT)
Display	Size / Aspect Ratio	10.4" TFT (4:3)	12.1" TFT (4:3)	15" TFT (4:3)	17" TFT (4:3)	19" TFT (4:3)
	Resolution	1024 x 768	1024 x 768	1024 x 768	1280 x 1024	1280 x 1024
	Colors	16.2 M	16.2 M	16.2 M	16.7 M	16.7 M
	Luminance (cd/m2)	350	500	400	350	350
	Contrast Ratio	1200:1	700:1	700:1	1000:1	1000:1
	Viewing Angle (H/V°)	176/176	160/160	160/160	140/170	160/150
	MTBF (hrs)	50,000	50,000	50,000	50,000	50,000
	Touch Screen	2pt PCT	2pt PCT	2/4pt PCT	2/4-point PCT	2/4pt PCT
Dimension (W x H x D, mm)		TBD	TBD	TBD	TBD	TBD
Weight (kg)		5	6	7.5	9.5	10.5
OSD Controller		Yes (rear)	Yes (rear)	Yes (rear)	Yes (rear)	Yes (rear)

Highlights

- 
-  IP65 compliant aluminum / stainless steel front bezel to provide basic waterproof protection against water spary from the front side
 -  Standard design to screw to the rack cabinet
 -  Hairy brushed finish to deliver an aesthetic appearance
 -  Seamless flat-bezel design between bezel and panel to decrease water / dust accumulation and to facilitate cleaning / maintenance
- AM / CM / KM / QM Series

QM Series Wide Temperature Sunlight Readable Rack Mount Multi Touch Monitor



-  Touch Function
  IP65 front bezel
-  Waterproof Design
-  Housing Design Aluminum front bezel + metal chassis
-  OSD Controller Rear side
-  Heat/cold-resistant -20°C ~ 55°C
-  Sunlight Readable Up to 1600 nit



Power Supply	DC in 12V external power adapter
I/O Ports (Default)	1 x VGA, 1 x DVI, 1 x USB or RS232 for PCT touch screen, 1 x Power terminal block
I/O Ports (Optional)	1 x HDMI (15" & 17")
Op. Temp. (Monitor)	-20°C ~ 55°C
Op. Temp. (Adapter)	-20°C ~ 50°C
Storage Temperature	-10°C ~ 70°C
Relative Humidity	0% ~ 95% non-condensing
OS Support	Win 7 Pro, Embedded 7, Win XP Pro, Embedded XP
Installation	19" rack mount & VESA mount 75 x 75 mm (10.4" & 12.1") / 100 x 100 mm (15" & 17")

Model Name		QM-ZJS10DF (2pt PCT)		QM-ZJS12DF (2pt PCT)		QM-ZJL15DF (2pt PCT) QM-ZJL15QF (4pt PCT)			QM-ZJL17DF (2pt PCT) QM-ZJL17QF (4pt PCT)	
Display	Size / Aspect Ratio	10.4" TFT (4:3)		12.1" TFT (4:3)		15" TFT (4:3)			17" TFT (4:3)	
	Resolution	1024 x 768		1024 x 768		1024 x 768			1280 x 1024	
	Colors	262K	16.2M	16.2M		16.7M	16.2M	16.7M	16.7M	
	Luminance (cd/m2)	1000	800	1600		1600	1000	800	1600	
	Contrast Ratio	600:1	1200:1	700:1		700:1	700:1	700:1	1000:1	
	Viewing Angle (H/V°)	178/178	176/176	160/160		160/160	160/160	160/160	170/160	
	MTBF (hrs)	70,000		70,000		70,000			70,000	
	Touch Screen	2pt PCT		2pt PCT		2/4pt PCT			2/4pt PCT	
Dimension (W x H x D, mm)		TBD		TBD		TBD			TBD	
Weight (kg)		5		6		7.5			9.5	
OSD Controller		Yes (rear)		Yes (rear)		Yes (rear)			Yes (rear)	

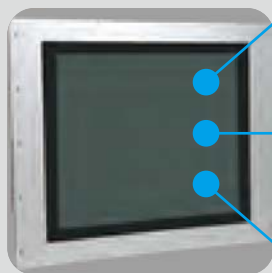
Highlights



AM / CM / KM / QM Series

-  7H hardness anti-scratch panel surface
to avoid touch function failure due to scratch
-  Oil- & water-stain-proof panel surface
to ensure touch sensitivity
-  Enhanced PCT touch panel
to enable input with glove which is necessary in some applications such as semiconductor / panel clean room, PCB or metal processing

SA Series Full IP65 Monitor



Touch Function



Waterproof Design



Housing Design



OSD Controller



IP65 chassis, IP65 connectors,
IP65 power adapter (alternative)

Stainless steel

Rear side

Power Supply	Standard / IP65-rated DC in 12V (default) or DC in 19V ~ 36V (optional) external power adapter
I/O Ports (Default)	1 x VGA, 1 x USB or RS232 for resistive touch screen
Operation Temperature	0°C ~ 45°C
Storage Temperature	-10°C ~ 70°C
Relative Humidity	0% ~ 95% non-condensing
OS Support	Win 7 Pro, Embedded 7, Win XP Pro, Embedded XP
Installation	VESA mount 100 x 100 mm
Optional Items	None touch screen

Model Name	12V	SA-ZJL15RF	SA-ZJL17RF	SA-ZJL19RF	SA-ZJD21RF
	19~36V	SA-ZJL15RW	SA-ZJL17RW	SA-ZJL19RW	SA-ZJD19RW
Display	Size / Aspect Ratio	15" TFT (4:3)	17" TFT (4:3)	19" TFT (4:3)	21.5" TFT (16:9)
	Backlight	LED	LED	LED	LED
	Resolution	1024 x 768	1280 x 1024	1280 x 1024	1920 x 1080
	Colors	16.2 M	16.7 M	16.7 M	16.7 M
	Luminance (cd/m ²)	400	350	250	300
	Contrast Ratio	700:1	1000:1	1000:1	5000:1
	Viewing Angle (H/V°)	160/160	140/170	170/160	178/178
	MTBF (hrs)	50,000	50,000	50,000	50,000
Touch Screen	5-wire resistive	5-wire resistive	5-wire resistive	5-wire resistive	
Dimension (W x H x D, mm)		380 x 290 x 67	425 x 361 x 68	455 x 367.6 x 67	TBD
Weight (kg)		8	9	10	11
I/O port's position		Bottom	Rear	Rear	Rear
OSD Controller		Yes (rear)	Yes (rear)	Yes (rear)	Yes (rear)

Highlights

IP65 compliant 6-sided sealed stainless steel chassis
to prevent liquid / dust from getting into the housing and
to resist acid- / alkali-based cleaning agents from corroding the device

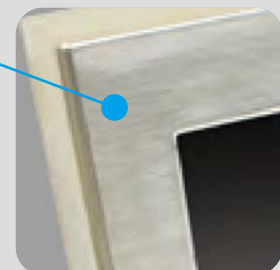

SA / HA / DA / LA Series

HA Series Sunlight Readable Full IP65 Monitor



Touch Function



IP65 chassis, IP65 connectors,
IP65 power adapter (alternative)



Waterproof Design



Housing Design

Stainless steel



OSD Controller

Rear side



Sunlight Readable

Up to 1600 nit

Power Supply	Standard / IP65-rated DC in 12V (default) or DC in 19V ~ 36V (optional) external power adapter
I/O Ports (Default)	1 x VGA, 1 x USB or RS232 for resistive touch screen
Operation Temperature	0°C ~ 45°C
Storage Temperature	-10°C ~ 70°C
Relative Humidity	0% ~ 95% non-condensing
OS Support	Win 7 Pro, Embedded 7, Win XP Pro, Embedded XP
Installation	VESA mount 100 x 100 mm
Optional Items	None touch screen

Model Name	12V	HA-ZJL15RF			HA-ZJL17RF			HA-ZJL19RF			HA-ZJD21RF		
	19~36V	HA-ZJL15RW			HA-ZJL17RW			HA-ZJL19RW			HA-ZJD21RW		
Display	Size / Aspect Ratio	15" TFT (4:3)			17" TFT (4:3)			19" TFT (4:3)			21.5" TFT (16:9)		
	Backlight	LED			LED			LED			LED		
	Resolution	1024 x 768			1280 x 1024			1280 x 1024			1920 x 1080		
	Colors	16.7 M	16.2 M	16.7 M	16.7 M	16.7 M	16.7 M	16.7 M	16.7 M	16.7 M	16.7 M	16.7 M	16.7 M
	Luminance (cd/m ²)	1600	1000	800	1600	1000	800	1600	1000	800	1600	1200	1000
	Contrast Ratio	700:1	700:1	700:1	1000:1	1000:1	1000:1	1000:1	1000:1	1000:1	900:1	1100:1	1000:1
	Viewing Angle (H/V°)	160/160	160/160	160/160	170/170	160/160	170/170	170/160	160/170	170/160	170/160	170/160	170/160
	MTBF (hrs)	70,000			70,000			70,000			70,000		
Touch Screen	5-wire resistive			5-wire resistive			5-wire resistive			5-wire resistive			
Dimension (W x H x D, mm)	380 x 290 x 67			425 x 361 x 68			455 x 367.6 x 67			TBD			
Weight (kg)	8			9			10			11			
I/O port's position	Bottom			Rear			Rear			Rear			
OSD Controller	Yes (rear)			Yes (rear)			Yes (rear)			Yes (rear)			

Highlights

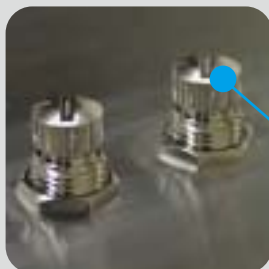

IP65 waterproof stainless steel connectors

to prevent liquid from getting into the housing via the cable entry points

SA / HA / DA / LA / TA / UA / EA / VA Series

DA Series Wide Temperature Full IP65 Monitor



Touch Function



IP65 chassis, IP65 connectors,
IP65 power adapter (alternative)



Waterproof Design



Housing Design

Stainless steel



OSD Controller

Rear side



Heat/cold-resistant

-20°C ~ 55°C

Power Supply	Standard / IP65-rated DC in 12V (default) or DC in 19V ~ 36V (optional) external power adapter
I/O Ports (Default)	1 x VGA, 1 x USB or RS232 for resistive touch screen
Op. Temp. for Monitor	-20°C ~ 55°C
Op. Temp. for Adapter	-20°C ~ 50°C
Storage Temperature	-25°C ~ 70°C
Relative Humidity	0% ~ 95% non-condensing
OS Support	Win 7 Pro, Embedded 7, Win XP Pro, Embedded XP
Installation	VESA mount 100 x 100 mm
Optional Items	None touch screen

Model Name	12V	DA-ZJL15RF	DA-ZJL17RF	DA-ZJL19RF
	19~36V	DA-ZJL15RW	DA-ZJL17RW	DA-ZJL19RW
Display	Size / Aspect Ratio	15" TFT (4:3)	17" TFT (4:3)	19" TFT (4:3)
	Backlight	LED	LED	LED
	Resolution	1024 x 768	1280 x 1024	1280 x 1024
	Colors	16.2 M	16.7 M	16.7 M
	Luminance (cd/m ²)	400	350	350
	Contrast Ratio	700:1	1000:1	1000:1
	Viewing Angle (H/V°)	160/160	140/170	160/150
	MTBF (hrs)	50,000	50,000	50,000
Touch Screen	5-wire resistive	5-wire resistive	5-wire resistive	
Dimension (W x H x D, mm)		380 x 290 x 67	425 x 361 x 68	455 x 367.6 x 67
Weight (kg)		8	9	10
I/O port's position		Bottom	Rear	Rear
OSD Controller		Yes (rear)	Yes (rear)	Yes (rear)

Highlights









IP65 rated external power adapter
to prevent liquid from getting into the interior
of the adapter from the junction of the shell



SA / HA / DA / LA / TA / UA / EA / VA Series

LA Series Wide Temperature Sunlight Readable Full IP65 Monitor



-  Touch Function
 -  Waterproof Design
 -  Housing Design
 -  OSD Controller
 -  Heat/cold-resistant
 -  Sunlight Readable
-  IP65 chassis, IP65 connectors, IP65 power adapter (alternative)
 -  Stainless steel
 -  Rear side
 -  -20°C ~ 55°C
 -  Up to 1600 nit

Power Supply	Standard / IP65-rated DC in 12V (default) or DC in 19V ~ 36V (optional) external power adapter
I/O Ports (Default)	1 x VGA, 1 x USB or RS232 for resistive touch screen
Op. Temp. for Monitor	-20°C ~ 55°C
Op. Temp. for Adapter	-20°C ~ 50°C
Storage Temperature	-25°C ~ 70°C
Relative Humidity	0% ~ 95% non-condensing
OS Support	Win 7 Pro, Embedded 7, Win XP Pro, Embedded XP
Installation	VESA mount 100 x 100 mm
Optional Items	None touch screen

Model Name	12V	LA-ZJL15RF			LA-ZJL17RF
	19~36V	LA-ZJL15RW			LA-ZJL17RW
Display	Size / Aspect Ratio	15" TFT (4:3)			17" TFT (4:3)
	Backlight	LED			LED
	Resolution	1024 x 768			1280 x 1024
	Colors	16.7 M	16.2 M	16.7 M	16.7 M
	Luminance (cd/m ²)	1600	1000	800	1600
	Contrast Ratio	700:1	700:1	700:1	1000:1
	Viewing Angle (H/V°)	160/160	160/160	160/160	170/160
	MTBF (hrs)	70,000			70,000
Touch Screen	5-wire resistive			5-wire resistive	
Dimension (W x H x D, mm)	380 x 290 x 67			425 x 361 x 68	
Weight (kg)	8			9	
I/O port's position	Bottom			Rear	
OSD Controller	Yes (rear)			Yes (rear)	

Highlights

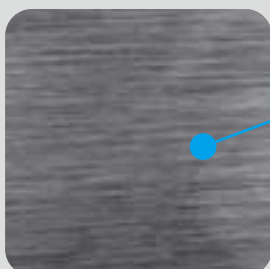

Hairy brushed finish
to deliver an aesthetic appearance

SA / HA / DA / LA / TA / UA / EA / VA Series

TA Series Full IP65 Multi Touch Monitor



Touch Function



Waterproof Design



Housing Design



OSD Controller



IP65 chassis, IP65 connectors,
IP65 power adapter (alternative)

Stainless steel

Rear side

Power Supply	Standard / IP65-rated DC in 12V (default) or DC in 19V ~ 36V (optional) external power adapter
I/O Ports (Default)	1 x VGA, 1 x USB or RS232 for touch screen
Operation Temperature	0°C ~ 45°C
Storage Temperature	-10°C ~ 70°C
Relative Humidity	0% ~ 95% non-condensing
OS Support	Win 7 Pro, Embedded 7, Win XP Pro, Embedded XP
Installation	VESA mount 100 x 100 mm

Model Name	12V	TA-ZJL15QF (4pt PCT) TA-ZJL15RF (resistive)	TA-ZJL17QF (4pt PCT) TA-ZJL17RF (resistive)	TA-ZJL19QF (4pt PCT) TA-ZJL19RF (resistive)	TA-ZJD21QF (4pt PCT) TA-ZJD21ZF (10pt PCT)
	19~36V	TA-ZJL15QW (4pt PCT) TA-ZJL15RW (resistive)	TA-ZJL17QW (4pt PCT) TA-ZJL17RW (resistive)	TA-ZJL19QW (4pt PCT) TA-ZJL19RW (resistive)	TA-ZJD21QW (4pt PCT) TA-ZJD21ZW (10pt PCT)
Display	Size / Aspect Ratio	15" TFT (4:3)	17" TFT (4:3)	19" TFT (4:3)	21.5" TFT (16:9)
	Backlight	LED	LED	LED	LED
	Resolution	1024 x 768	1280 x 1024	1280 x 1024	1920 x 1080
	Colors	16.2 M	16.7 M	16.7 M	16.7 M
	Luminance (cd/m ²)	400	350	250	300
	Contrast Ratio	700:1	1000:1	1000:1	5000:1
	Viewing Angle (H/V°)	160/160	140/170	170/160	178/178
	MTBF (hrs)	50,000	50,000	50,000	50,000
Touch Screen	4pt PCT / 5-wire resistive	4pt PCT / 5-wire resistive	4pt PCT / 5-wire resistive	4/10pt PCT	
Dimension (W x H x D, mm)	438.2 x 335 x 63	470 x 390 x 67.1	521.4 x 434.4 x 67.1	607 x 401 x 67.1	
Weight (kg)	9	10	11	12	
I/O port's position	Rear	Rear	Rear	Rear	
OSD Controller	Yes (rear)	Yes (rear)	Yes (rear)	Yes (rear)	

Highlights

IP65 compliant 6-sided sealed stainless steel chassis
to prevent liquid / dust from getting into the housing and
to resist acid- / alkali-based cleaning agents from corroding the device

Seamless flat-bezel design between chassis and panel
to decrease water / dust accumulation and
to facilitate cleaning / maintenance

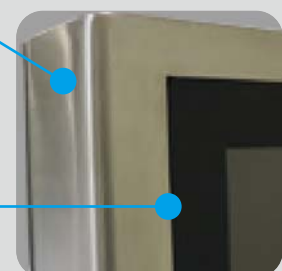

TA / UA / EA / VA Series

UA Series Sunlight Readable Full IP65 Multi Touch Monitor



Touch Function



IP65 chassis, IP65 connectors, IP65 power adapter (alternative)



Waterproof Design



Housing Design

Stainless steel



OSD Controller

Rear side



Sunlight Readable

Up to 1600 nit

Power Supply	Standard / IP65-rated DC in 12V (default) or DC in 19V ~ 36V (optional) external power adapter
I/O Ports (Default)	1 x VGA, 1 x USB or RS232 for PCT touch screen
Operation Temperature	0°C ~ 45°C
Storage Temperature	-10°C ~ 70°C
Relative Humidity	0% ~ 95% non-condensing
OS Support	Win 7 Pro, Embedded 7, Win XP Pro, Embedded XP
Installation	VESA mount 100 x 100 mm

Model Name	12V	UA-ZJL15QF (4pt PCT) UA-ZJL15RF (resistive)			UA-ZJL17QF (4pt PCT) UA-ZJL17RF (resistive)			UA-ZJL19QF (4pt PCT) UA-ZJL19RF (resistive)			UA-ZJD21QF (4pt PCT) UA-ZJD21ZF (10pt PCT)		
	19~36V	UA-ZJL15QW (4pt PCT) UA-ZJL15RW (resistive)			UA-ZJL17QW (4pt PCT) UA-ZJL17RW (resistive)			UA-ZJL19QW (4pt PCT) UA-ZJL19RW (resistive)			UA-ZJD21QW (4pt PCT) UA-ZJD21ZW (10pt PCT)		
Display	Size / Aspect Ratio	15" TFT (4:3)			17" TFT (4:3)			19" TFT (4:3)			21.5" TFT (16:9)		
	Backlight	LED			LED			LED			LED		
	Resolution	1024 x 768			1280 x 1024			1280 x 1024			1920 x 1080		
	Colors	16.7 M	16.2 M	16.7 M	16.7 M	16.7 M	16.7 M	16.7 M	16.7 M	16.7 M	16.7 M	16.7 M	16.7 M
	Luminance (cd/m ²)	1600	1000	800	1600	1000	800	1600	1000	800	1600	1200	1000
	Contrast Ratio	700:1	700:1	700:1	1000:1	1000:1	1000:1	1000:1	1000:1	1000:1	900:1	1100:1	1000:1
	Viewing Angle (H/V°)	160/160	160/160	160/160	170/170	160/160	170/170	170/160	160/170	170/160	170/160	170/160	170/160
	MTBF (hrs)	70,000			70,000			70,000			70,000		
	Touch Screen	4pt PCT / 5-wire resistive			4pt PCT / 5-wire resistive			4pt PCT / 5-wire resistive			4/10pt PCT		
Dimension (W x H x D, mm)	438.2 x 335 x 63			470 x 390 x 67.1			521.4 x 434.4 x 67.1			607 x 401 x 67.1			
Weight (kg)	9			10			11			12			
I/O port's position	Rear			Rear			Rear			Rear			
OSD Controller	Yes (rear)			Yes (rear)			Yes (rear)			Yes (rear)			

Highlights

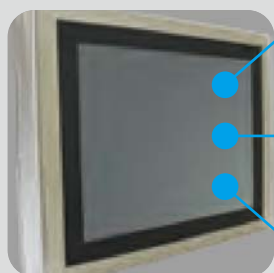

TA / UA / EA / VA Series

● 7H hardness anti-scratch panel surface
to avoid touch function failure due to scratch

● Oil- & water-stain-proof panel surface
to ensure touch sensitivity

● Enhanced PCT touch panel
to enable input with glove which is necessary in some applications such as semiconductor / panel clean room, PCB or metal processing

EA Series Wide Temperature Full IP65 Multi Touch Monitor



Touch Function



IP65 chassis, IP65 connectors, IP65 power adapter (alternative)



Waterproof Design



Housing Design

Stainless steel



OSD Controller

Rear side



Heat/cold-resistant

-20°C ~ 55°C

Power Supply Standard / IP65-rated DC in 12V (default) or DC in 19V ~ 36V (optional) external power adapter

I/O Ports (Default) 1 x VGA, 1 x USB or RS232 for PCT touch screen

Op. Temp. for Monitor -20°C ~ 55°C

Op. Temp. for Adapter -20°C ~ 50°C

Storage Temperature -25°C ~ 70°C

Relative Humidity 0% ~ 95% non-condensing

OS Support Win 7 Pro, Embedded 7, Win XP Pro, Embedded XP

Installation VESA mount 100 x 100 mm

Model Name	12V	EA-ZJL15QF (4pt PCT) EA-ZJL15RF (resistive)	EA-ZJL17QF (4pt PCT) EA-ZJL17RF (resistive)	EA-ZJL19QF (4pt PCT) EA-ZJL19RF (resistive)
	19~36V	EA-ZJL15QW (4pt PCT) EA-ZJL15RW (resistive)	EA-ZJL17QW (4pt PCT) EA-ZJL17RW (resistive)	EA-ZJL19QW (4pt PCT) EA-ZJL19RW (resistive)
Display	Size / Aspect Ratio	15" TFT (4:3)	17" TFT (4:3)	19" TFT (4:3)
	Backlight	LED	LED	LED
	Resolution	1024 x 768	1280 x 1024	1280 x 1024
	Colors	16.2 M	16.7 M	16.7 M
	Luminance (cd/m ²)	400	350	350
	Contrast Ratio	700:1	1000:1	1000:1
	Viewing Angle (H/V°)	160/160	140/170	160/150
	MTBF (hrs)	50,000	50,000	50,000
Touch Screen	4pt PCT / 5-wire resistive	4pt PCT / 5-wire resistive	4pt PCT / 5-wire resistive	
Dimension (W x H x D, mm)	438.2 x 335 x 63	470 x 390 x 67.1	521.4 x 434.4 x 67.1	
Weight (kg)	9	10	11	
I/O port's position	Rear	Rear	Rear	
OSD Controller	Yes (rear)	Yes (rear)	Yes (rear)	

Highlights

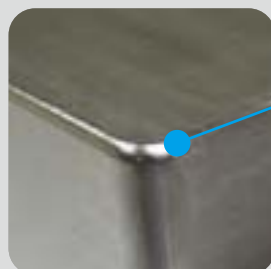

Smooth chamfer corner

SA / HA / DA / LA / TA / UA / EA / VA Series

VA Series Wide Temperature Sunlight Readable Full IP65 Multi Touch Monitor



Touch Function



IP65 chassis, IP65 connectors, IP65 power adapter (alternative)



Waterproof Design



Housing Design

Stainless steel



OSD Controller

Rear side



Heat/cold-resistant

-20°C ~ 55°C



Sunlight Readable

Up to 1600 nit

Power Supply Standard / IP65-rated DC in 12V (default) or DC in 19V ~ 36V (optional) external power adapter

I/O Ports (Default) 1 x VGA, 1 x USB or RS232 for PCT touch screen

Op. Temp. for Monitor -20°C ~ 55°C

Op. Temp. for Adapter -20°C ~ 50°C

Storage Temperature -25°C ~ 70°C

Relative Humidity 0% ~ 95% non-condensing

OS Support Win 7 Pro, Embedded 7, Win XP Pro, Embedded XP

Installation VESA mount 100 x 100 mm

Model Name	12V	VA-ZJL15QF (4pt PCT) VA-ZJL15RF (resistive)			VA-ZJL17QF (4pt PCT) VA-ZJL17RF (resistive)	
	19~36V	VA-ZJL15QW (4pt PCT) VA-ZJL15RW (resistive)			VA-ZJL17QW (4pt PCT) VA-ZJL17RW (resistive)	
Display	Size / Aspect Ratio	15" TFT (4:3)			17" TFT (4:3)	
	Backlight	LED			LED	
	Resolution	1024 x 768			1280 x 1024	
	Colors	16.7 M	16.2 M	16.7 M	16.7 M	
	Luminance (cd/m ²)	1600	1000	800	1600	
	Contrast Ratio	700:1	700:1	700:1	1000:1	
	Viewing Angle (H/V°)	160/160	160/160	160/160	170/160	
	MTBF (hrs)	70,000			70,000	
Touch Screen	4pt PCT / 5-wire resistive			4pt PCT / 5-wire resistive		
Dimension (W x H x D, mm)	438.2 x 335 x 63			470 x 390 x 67.1		
Weight (kg)	9			10		
I/O port's position	Rear			Rear		
OSD Controller	Yes (rear)			Yes (rear)		

Highlights

OSD controller
default & located in rear side

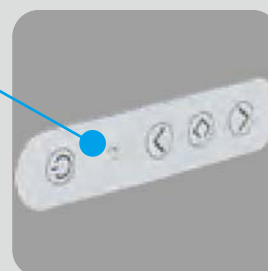

SA / HA / DA / LA / TA / UA / EA / VA Series



Inspiring a reliable solution

Tel: 886-2-6621-8811

Fax: 886-2-8226-1518

sales@kingdy.com.tw

<http://www.kingdy.biz>

10F, No. 2, Jian 8th Rd., Zhonghe Dist.,
New Taipei City 23511 Taiwan